

% 9 ' 6 6	5 ' 6 2 1	,
9	P Ÿ	\$

- z 60V,3.2A, RDS(ON) =75 P # 9 * 6 9
- z Improved dv/dt capability
- z Fast switching
- z 100% EAS Guaranteed
- z Green Device Available

- z Motor Drive
- z Power Tools
- z LED Lighting

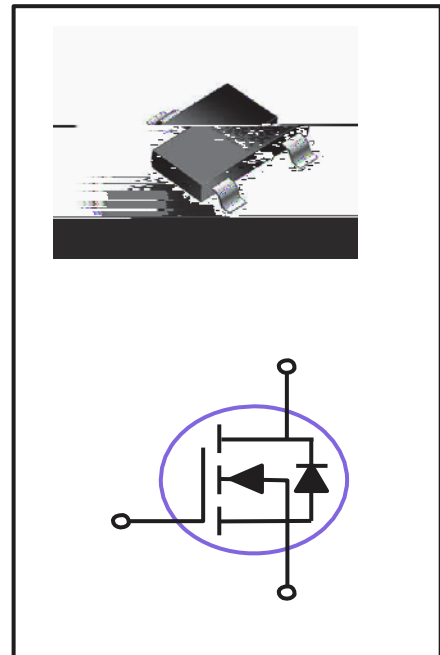

f & \$ PELHQW 7HP SHUDWXUH XQOHVV RWKHU ZLVH QRWHG

'UDLQ 6RXUFH 9ROWDJH	9 ₆		9
*DWH 6RXUROWDJH	9 ₆	"	9
'UDLQ & XUHQW ± & RQWLQRRXV 7	;		\$
'UDLQ & XUHQW ± & RQWLQRRXV 7			
'UDLQ & XUHQW ± 3XOVHG	;		\$
3RZHU 'LVVLSDWLRQ 7	3		:
3RZHU 'LVVLSDWLRQ ± HUDWH DERYH		:	•
6WRUDJH 7HP SHUDWXUH 5DQJH	7 _{67*}	WR	•
2SHUDWLQJ -XQFWLRQ 7HP SHUDWXUH 5DQJH	5DQJH	WR	•

7\$ FXQOHVV RWKHUZZLVH VSHFLILHG

'UDLQ	6RXUFH	%UHDNGRZQ	9%Q	WDJH	9	,	X\$
-------	--------	-----------	-----	------	---	---	-----

1RUPDOLJHG 7KHUPD.Q 5HVSRRQWHPDOLJHG *DWH 7KHUVKROG 9RQWHLQRRXV 'UDLQ &XUUHQW

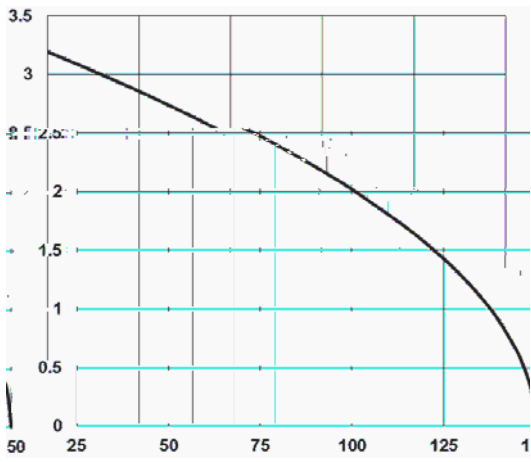

7& &DVH 7HPSH UDWXUH

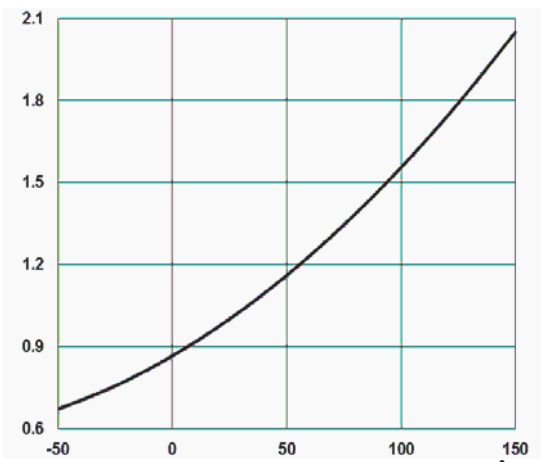

7. -XQFWLRQ 7HPSH UDWXUH

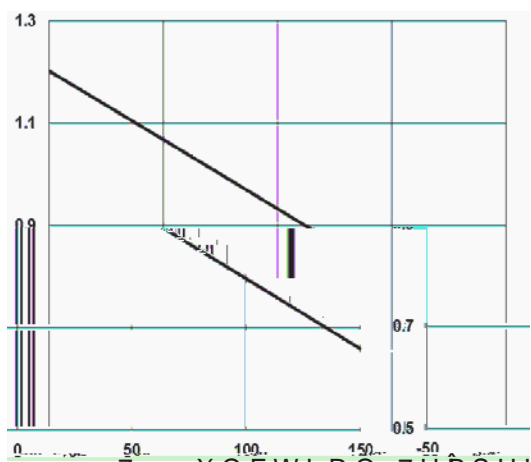

7. -XQFWLRQ 7HPSH UDWXUH

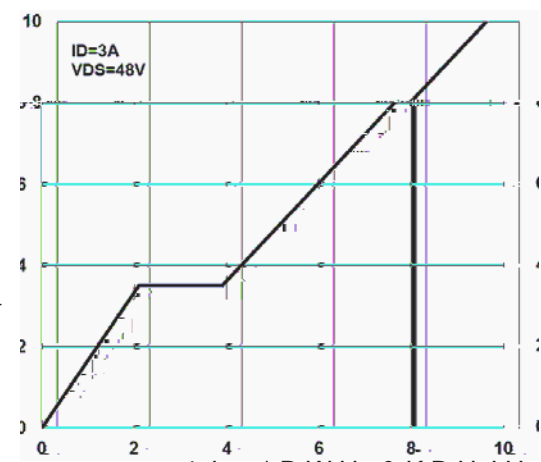

4J *DWH &KDUJH Q&

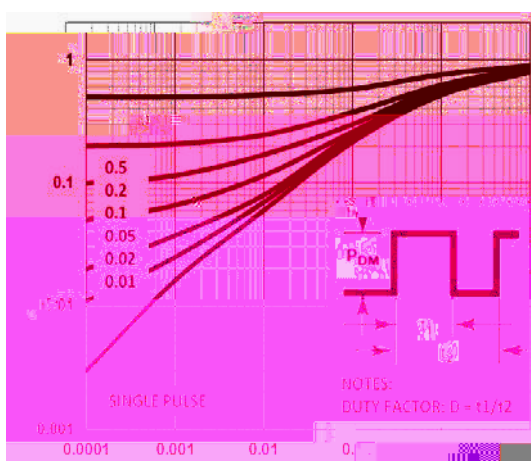

6TXDUH :DYH 3XOVH 'XUDWLRQ V 9_6 'UDLQ WR 6RXUFH 9ROWD

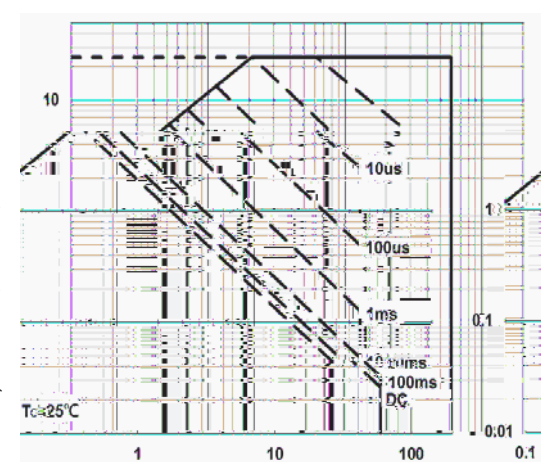

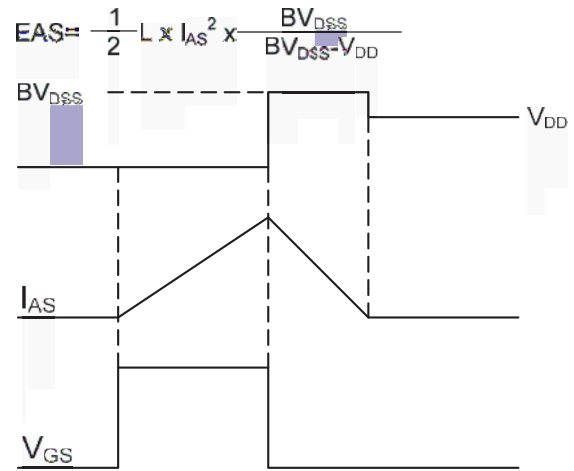
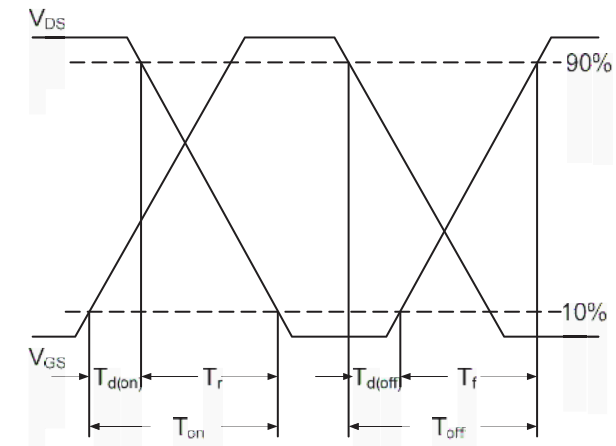

6 2 7

6 3 \$ & . \$ * (, 1) 2 5 0 \$ 7 , 2 1

